



中山市川狼五金制品厂

ZHONG SHAN CHUAN LANG LIGHTING CO., LTD

型号: 碟狼513-400W-T90
飞狼投光灯400W

外观图

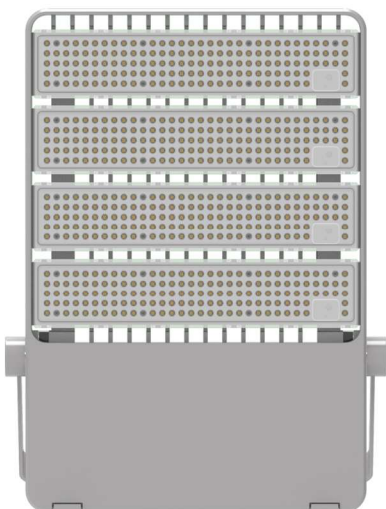

线条图

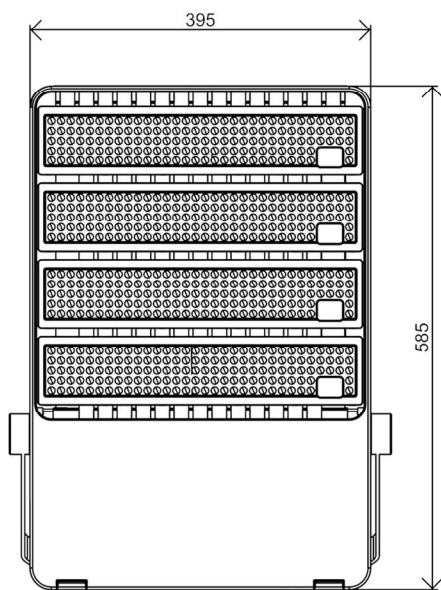

主视图

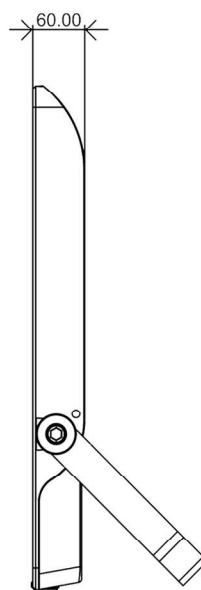

左视图



俯视图

外形尺寸:L395*W585*H60mm

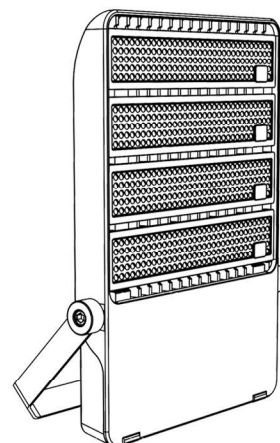

透视图

铝基板-透镜

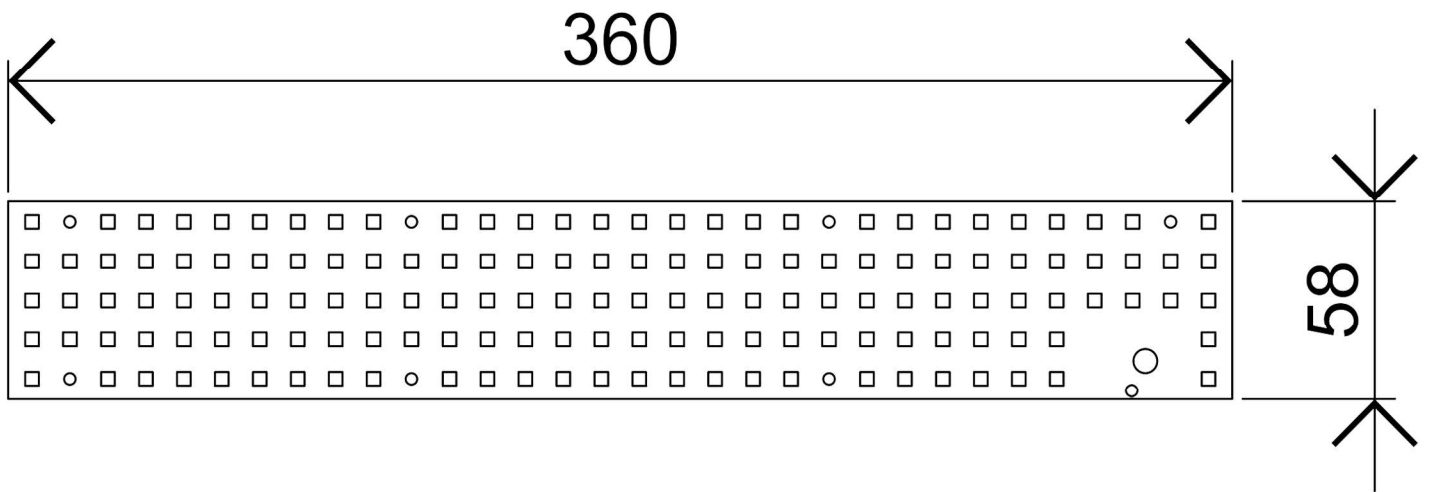

铝基板:360mm*58mm*T1.2mm 3030LED

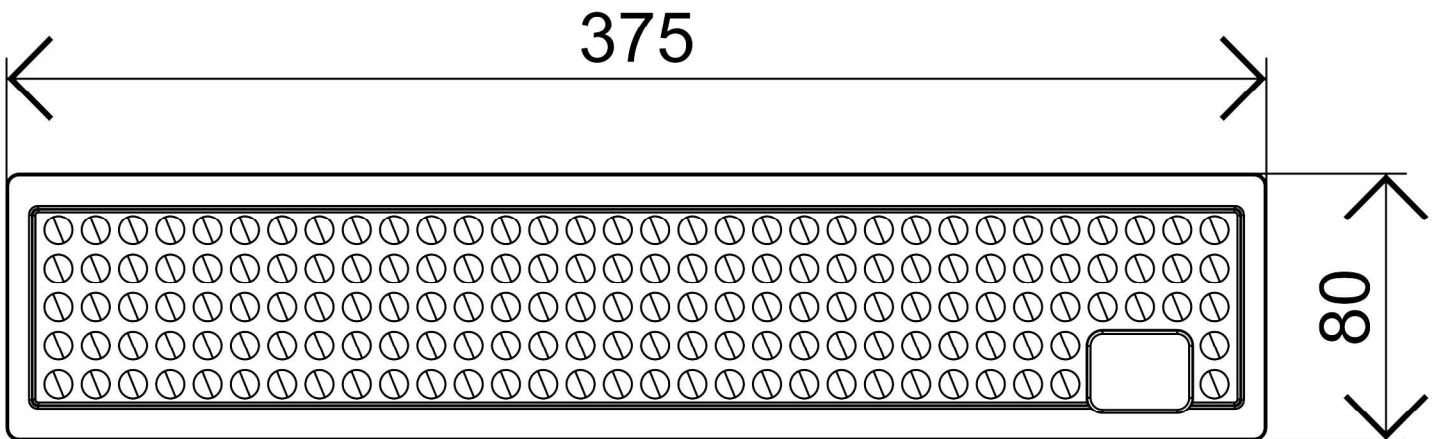

透镜:375mm*80mm*T23mm 光束角30度-60度-90度

灯体尺寸孔位

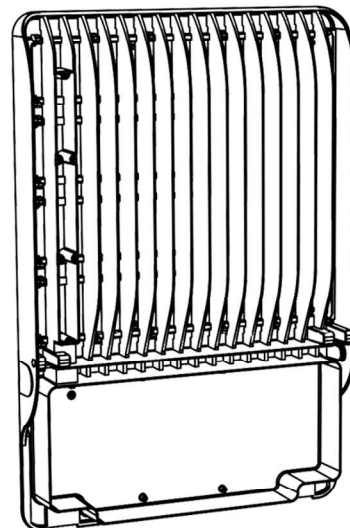
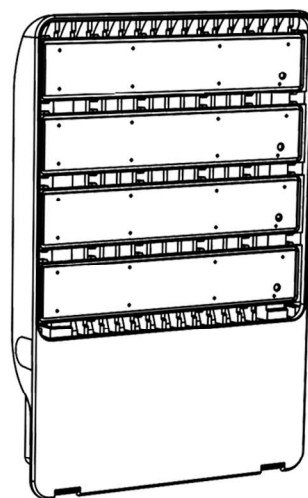
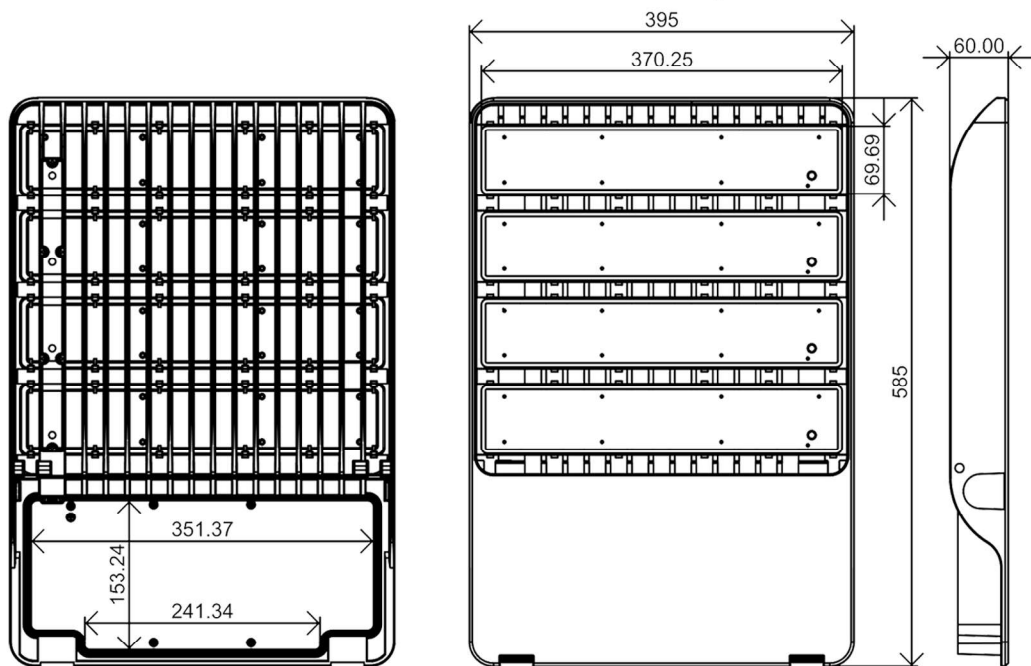
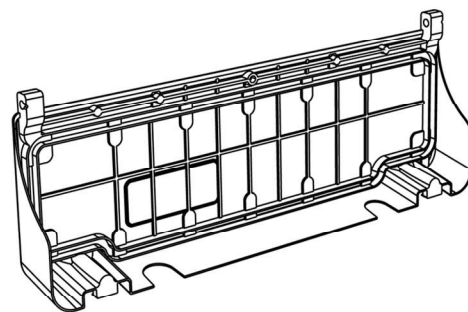
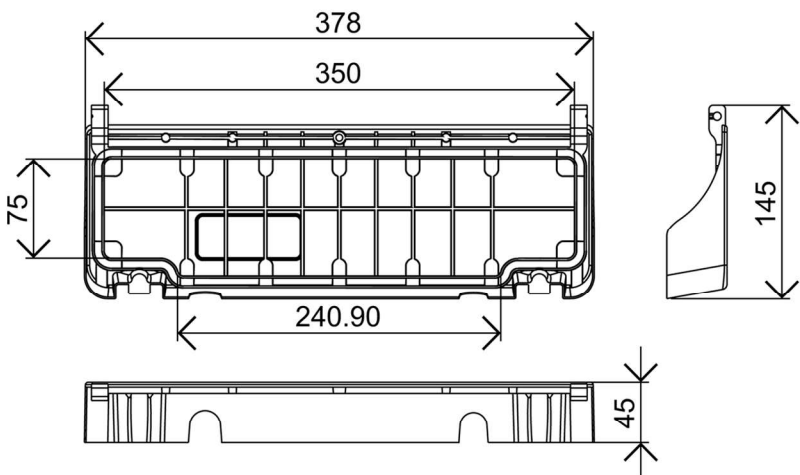
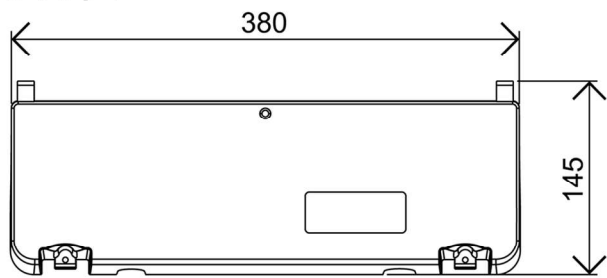

爆炸图

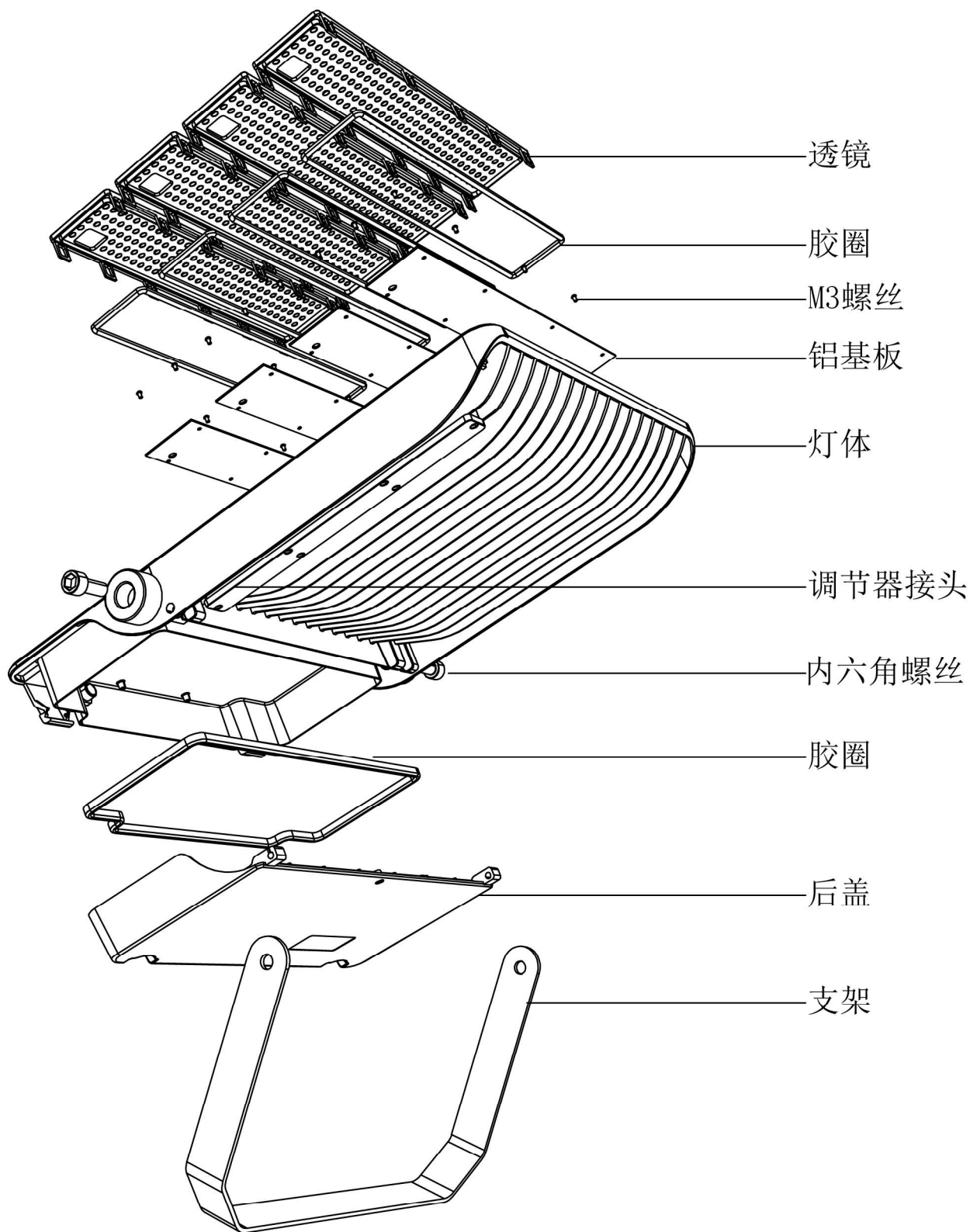

包装尺寸

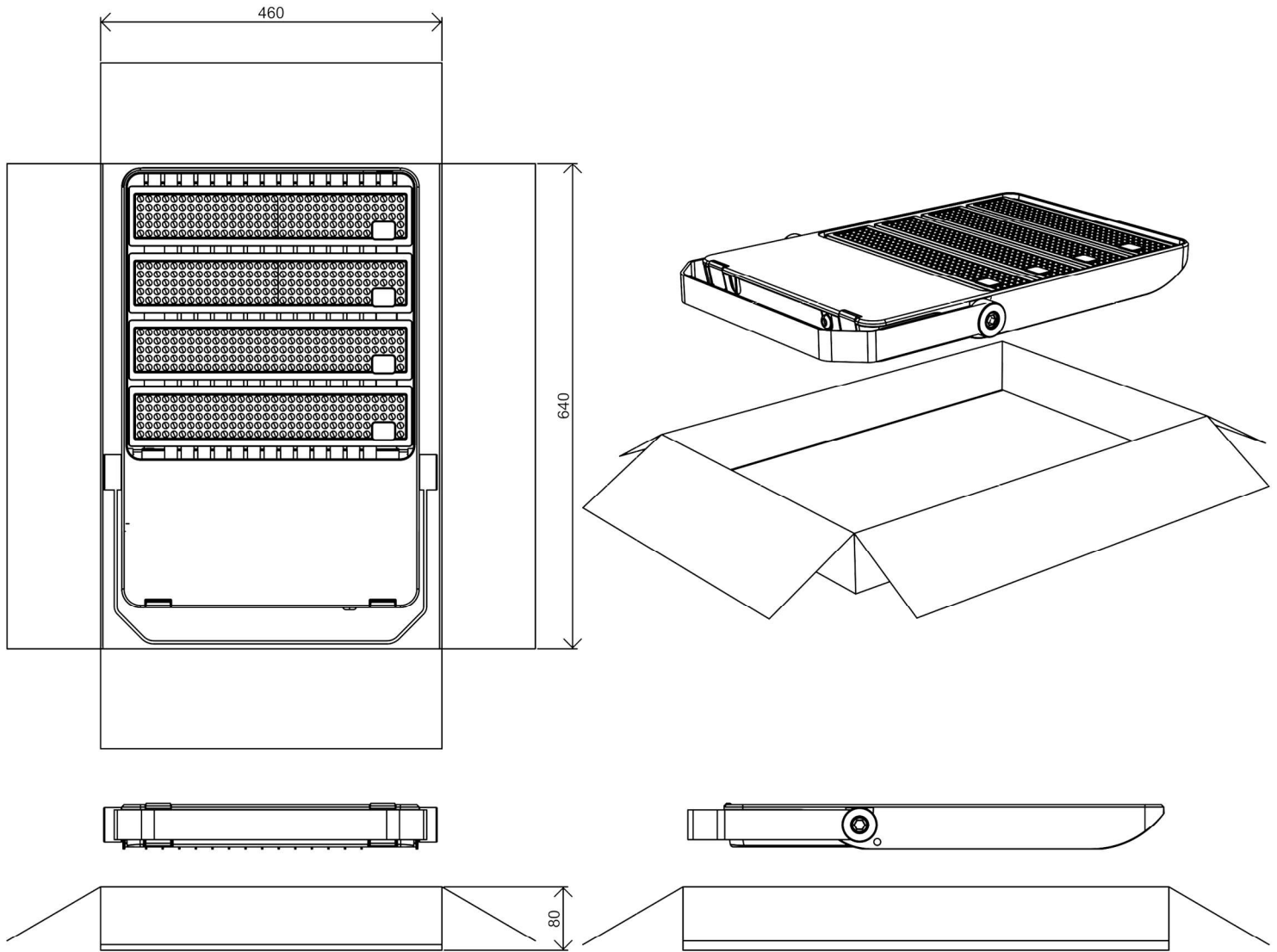

外箱尺寸：450mm*640mm*H80mm

包装总重量：5.0KG